

Compound Security Systems Ltd

VX402R



MULTI STABILISED OUTDOOR DETECTOR

2 YEAR WARRANTY

- Low Current Draw 10uA (In Standby).
- Battery Saving Circuit The alarm circuit will not be activated until there is a 5 or 120 seconds period of inactivity in the pattern area.
- Operates on Wide Range of Power 3-9V Alkaline Battery or Lithium Battery.
- Back box for a wireless transmitter Backbox can conceal a wireless transmitter circuitboard (W63mm x H140mm x D31mm).
- Limited Detection Range Function The detection range of the VX-402R can be limited to avoid detecting unwanted objects. By limiting the detection range, false alarms due to unwanted movement (i.e. cars, persons or animals outside the protected area) can be reduced.
- Size Judging Function VX-402R is designed to discriminate between large and small animals. By utilizing this ability, false alarms due to small animals can be reduced.
- Bright Light Disturbance Immunity VX-402R is equipped with Double Conductive Shielding (Patent Listed). This shielding greatly reduces the chance of false alarms due to car headlights, sunlight and other ambient light sources.

Safety-Related Precautions

- Before installation,make sure to read this instruction manual carefully for safe and effective product operation.
- After reading this installation manual, make sure to keep it in a convenient place for future use.

Warning	This icon denotes a situation involving the risk of serious injury or even death, if the warning given is ignored.
Caution	Denotes a situation involving the risk of serious injury or damage to property if the warning is ignored.

- This icon indicates actions to be avoided. Details of the actions to be avoided are written beside or near icon.
- This icon indicates instructions that should be strictly followed.

Warning	Never use this product for any application except purpose for detecting moving target such as a human or a car. In addition, never use for any activation for a shutter or other. It may cause hazards.	
	Never attempt to disassemble or modify the product, which increases the risk of fire or damage of the product.	
	Never attempt to connect the terminals to units which require higher power supply or current draw than its rating. It increases the risk of fire or damage to the product.	
Caution	To avoid the risk of damaging the product, never touch the main body of the product with wet hands. (Also, if the product is wet after rain do not touch it)	
	Avoid applying water in directly from brackets, houses, or otherwise splashing water directly onto the product. It increases the risk of damaging the product.	
	Clean and inspect the device periodically for safe operation. If any defect is detected, ask your local supplier to repair the device.	

1.INSTALLATION HINTS

Select a place for installing the VX-402R while keeping the following points in mind.

1.Perpendicular Installation

Install the sensor perpendicular to the ground to making upper detection area parallel to the ground.

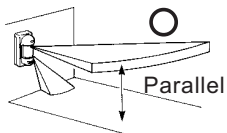

If the sensor is installed with some angle to the ground, operational reliability of the sensor may be decreased.

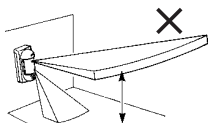

2. Installation height

Installation height is 0.8m-1.2m (2.7ft-4ft)

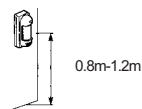

3.Detection Area Setup

The detection area has directionality. Mount the detector so that it must be passed in order to gain entry.

VX-402R is designed to protect any light disturbances. However , too much light such as; strong sunlight directed or reflected exactly into the sensor's field of view may cause unstable operation. It is recommended to avoid installing in such a place.

Avoid pointing the sensor towards moving objects (i.e. swaying trees, bushes, flags,etc.). If moving objects are unavoidable, please refer to TROUBLE SHOOTING reference for proper installation.

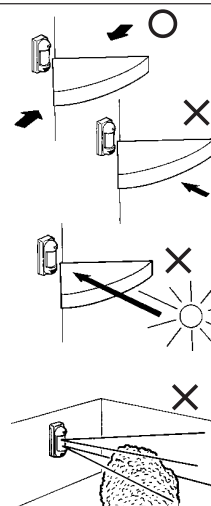

2. DESCRIPTION AND OPERATION

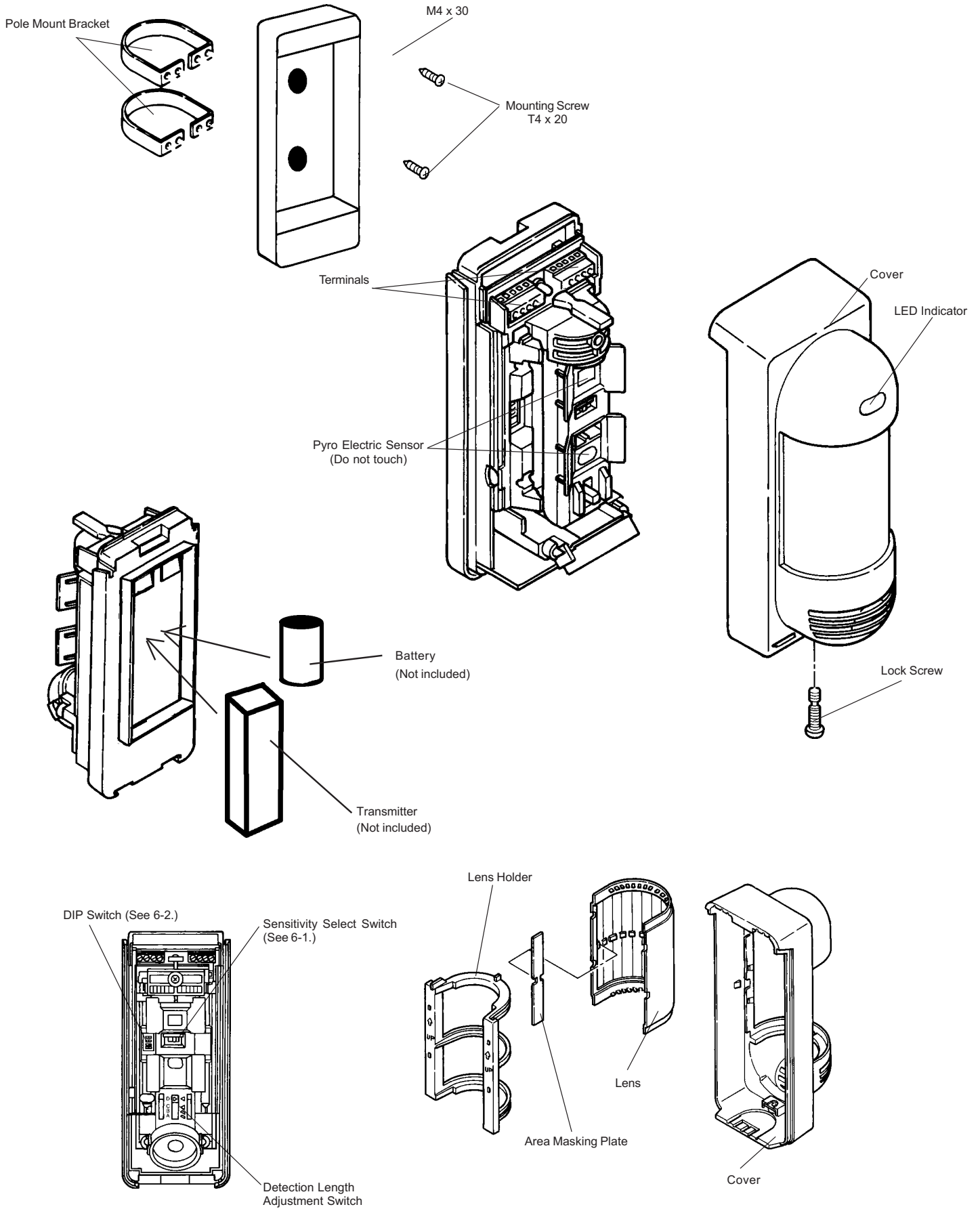

3. INSTALLATION

3-1. Before the Installation

(1) Loosen the lock screw and remove the cover.

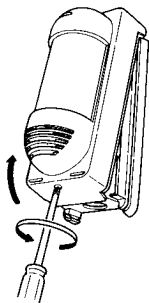

(2) Remove the screws fastening the back box.

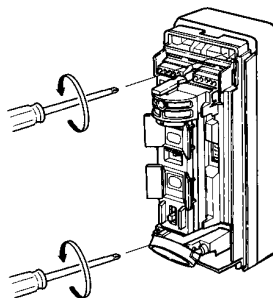

(3) Remove the back box.

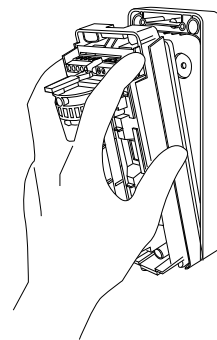

3-2. Wall Mount

(1) Install the back box on the wall with the mounting screws provided (two places).

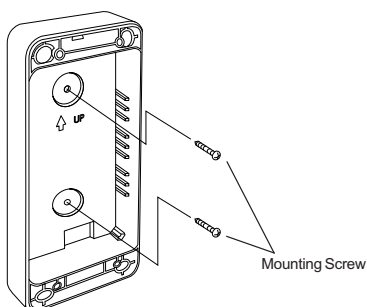

(2) Pass the wiring through the wiring port of the detector. After connecting the wires to the terminals (See 4. Wiring), insert the water protection sponge so that it blocks the wiring port as shown in the figure. Mount the detector on the back box.

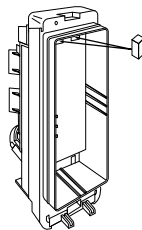

(3) Fasten with screws

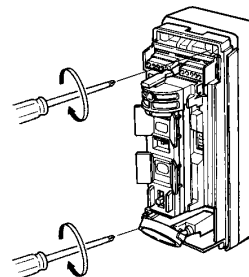

(4) Adjust the DIP switch (See 6 Switch set up), detectio area and sensitivity (See 5 Setting & Adjustment). Secure the cover with the lock screw.

IMPORTANT!

- Install the unit perpendicular to the ground.
- Installation height must be between 0.8m and 1.2m (2.7 ft and 4 ft).
- Secure a space 110mm (4.4") or more to the upper part of plate for opening and closing of the cover.
- Make sure that the rubber packing is seated correctly in its groove when you connect the detector with its back box.

3-3. Pole Mount

An installation pole with an outside diameter of 43-48mm (1.66"-) must be used.

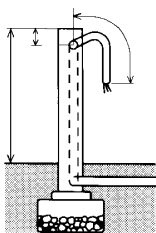

Mount the mounting brackets on the back box with tap screws (two places).

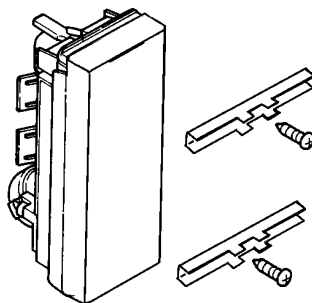

Fasten the U-brackets on the pole with the M4 x 30 screws provided. Mount in accordance with the wall mounting procedure.

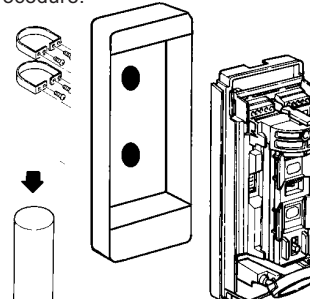

4. WIRING

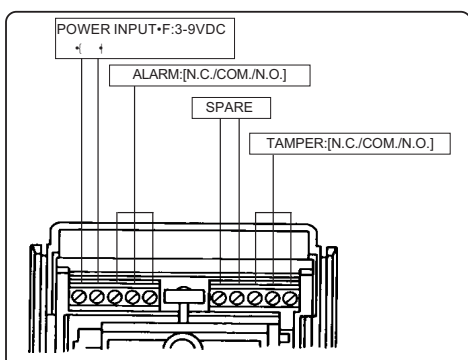

When using VX-402R and transmitter together, the battery life will be shortened depending on the transmitter type (Current Draw). Only the expected battery life of VX-402R is shown in the following chart. Battery life will change according to the temperature.

Battery Life (VX-402R only)	Approx. 3 years / 9V Alkaline Battery(560mAh), Interval 120sec
	Approx. 2 years / 9V Alkaline Battery(560mAh), Interval 5sec
	Approx. 8 years / 3V Lithium Battery(1300mAh), Interval 120sec
	Approx. 5 years / 3V Lithium Battery(1300mAh), Interval 5sec

5.SETTING & ADJUSTMENTS

5-1.Detection Length Adjustment

Length of Lower Detection Area decides detection length

The upper detection area stays parallel to the ground at all time. The lower detection area moves as shown above depending on the switch position. Detection length is therefore limited by the length of lower detection area, since both upper and lower detection area have to be blocked at the same time to activate the sensor.

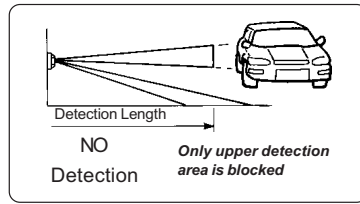
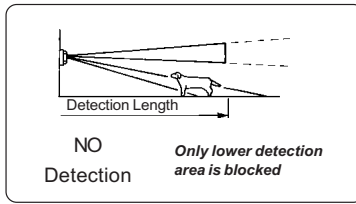
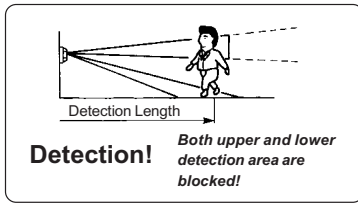

Press and slide the detection length adjustment switch to the desired position.

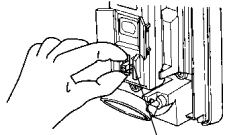

Detection Length Adjustment Switch

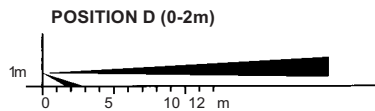
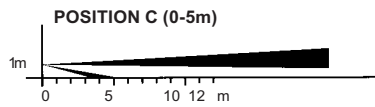
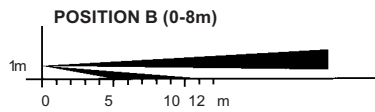
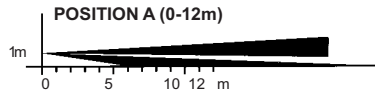
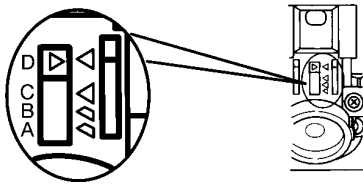

Detection Length setting chart

POSITION	MAX DETECTION LENGTH	
	Standard	*
A	12.0	10.0 - 15.0
	(40.0)	(33.3 - 50.0)
B	8.0	6.0 - 10.0
	(26.7)	(20.0 - 33.3)
C	5.0	4.0 - 5.5
	(16.7)	(13.3 - 18.3)
D	2.0	1.5 - 2.5
	(6.7)	(5.0 - 8.3)

Instration Height=1m (3.3ft)

*The maximum detection length may vary as above due to environmental thermal conditions.

IMPORTANT!

- This product detects temperature differences between the moving object and the background temperature in the detection area. If the object does not move, the detector can not detect it.
- This product has directional characteristic it is difficult to detect the target that is approaching the detector.
- If there is a traffic near the detection area, please adjust detection 1.5m to 2.0m (5ft to 7ft) away from movements.

5-2.Area Angle Adjustment

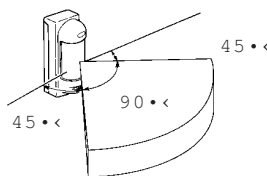
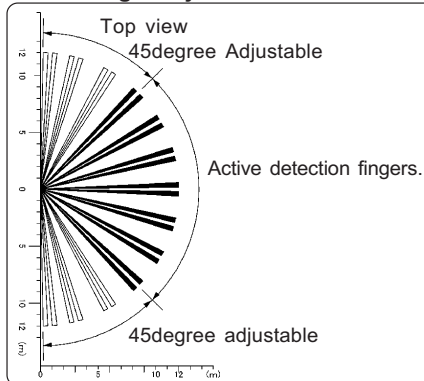

Area angle is 90degree with 7 fingers by 15degree per notch.
(If you want to reduce the number of fingers, fasten the lens with the area masking plate provided.)

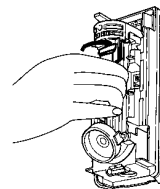

Hold the pyro electric unit and turn it to the desired direction (15degree steps).

Lens and area correspondence as seen from the inside

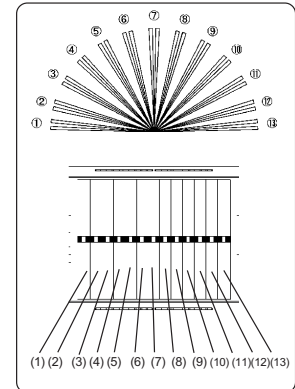

5-3.Area Masking

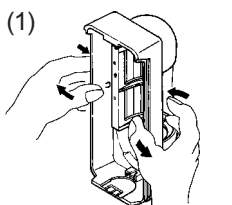

1.Remove the lens holder from the cover as shown above.

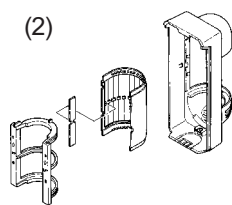

2.Separate the lens from the cover. Apply the provided area masking plate to the inside of the lens on the zone to be eliminated.

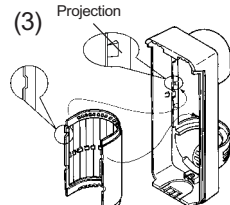

3.Put the lens back in by aligning the 4 projections on the cover to the 4 cut outs on the lens.
(The lens has vertical orientation. Be sure the lens is correctly orientated when mounting.)

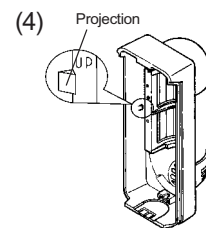

4.Mount the lens holder. make sure the lens holder is held by left and right prongs on the cover.

(Make sure the tabs [2] on the left and right are engaged.)

IMPORTANT!

As shown above 5-2, there are always 7 active detection fingers. If the area masking plate is not applied, the active fingers are varied by area adjustment as explained at left. Please check which fingers are active before applying area masking plate.

6. Switch Setup

6-1. Sensitivity Adjustment

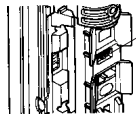

Sensitivity Select Switch (L,M,H)

When greater sensitivity is desired, select "H". When the installation site is poor (bad conditions) select "L".

6-2. DIP Switch Adjustment

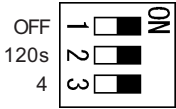

ON 1. Walk Test
5s 2. Battery Saving Timer
2 3. Pulse Count

1) Walk Test

·ON (Walk Test Mode)

1) LED will light when detector is tripped.

2) Alarm will be generated instantly on detection.

·OFF (Battery Saving Mode)

1) LED is off.

2) Battery Saving Timer

: Alarm output activations are limited by a timer selection - 5 or 120 seconds. Even if there are continuous alarm events, the alarm output operates only once in the timer period which can be between 5 and 120 seconds.

3) Pulse Count

: Selectable pulse count 2 or 4.

7. OPERATION TEST

1. Turn walk test switch on.
2. Check and adjust the detection area.

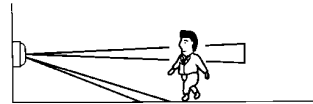

IMPORTANT!

- 1) When the car or person goes near the detection area (a), please adjust the detection area 1.5m to 2m (5ft to 7ft) shorter than movement area (b) and confirm by walk test. This is because, the actual detection area may change from 1.5m to 2m (5ft to 7ft) due to the environmental thermal conditions.

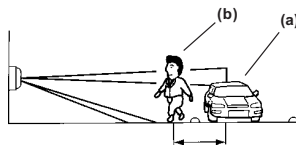

The detection area might increase when there is a big temperature difference between the moving object and the background.

Example

If the detection length adjusted to **position A [12m (40ft)]**, there is a possibility to detect the car, depending on the environmental thermal conditions.

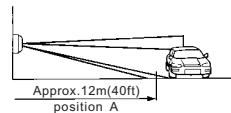

In such case,

- 1) Please adjust the detection length to **position B**. The detection length will be around **8m (27ft)** which is rather shorter than ideal length but can remove the chance of false detection.

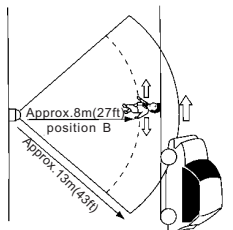

- 2) Confirm by walk test. **Detects at area a and no detection at area b.**

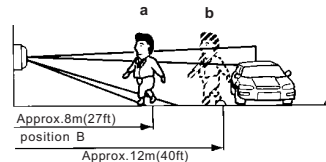

- 2) VX-402R has a multi-level detection pattern (from side view). A heat source beyond the detection area may cause the detector to issue a false alarm by reflecting off the ground. Examples of reflective ground is water (puddle), wet road, smooth surface concrete and asphalt road.

Reflection rate is not 100% of course on the ground, however, if the heat source is strong and / or reflection rate is high, detection distance will be longer than required and may detect unwanted objects beyond. Select the detection ground position, according to the ground condition of the installation site.

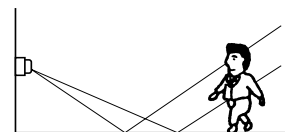

8.TROUBLE SHOTING

PROBLEM	PROBABLE CAUSE	REMEDY
No alarm event even though someone is walking in detection area.	Incorrect power supply voltage.	Set supply voltage for a range of 3 to 9 battery.
	Faulty wiring to detector. Transmitter is not connected to VX-402R.	Rewire alarm correctly.
	Wireless transmission dose not reach the receiver.	Check transmitter.
	Battery is dead.	Change batteries.
	Walk Test Switch is OFF.	Battery saving circuit .
LED blinks continuously	Incorrect power supply voltage.	Set supply voltage for a range of 3 to 9 battery.
Make alarms even though no moving object is in the area	Detector is not installed perpendicularly to the ground.	Reinstall the detector perpendicularly to the ground.
	Lower detection area is unnecessarily long.	Confirm and reset the detection area.
	Lower detection area receives reflected sunlight or car light, etc.	Remove the reflector or reset the detection area or mask the area exposed to reflected light.
	Lower detection area is exposed to direct sunlight or car light.	Reset the area so it may not receive direct light.
	There is any heat source (stove or heater, etc.) in the area that may cause temperature change.	Reset the area or remove the heat source.
	There is any moving object (laundry on clothesline, plants, etc.) in the area.	Reset the area or remove moving objects.
No detection occasionally	Detection area is not set appropriately.	Reset the area appropriately.
	Sensitivity is set for L(ow).	Reset sensitivity for M(edium) or H(igh).

9.SPECIFICATION

MODEL	VX-402R
Detection Method	Passive Infrared
Coverage	12m(40ft)90° wide
Detection Zone	14zones
Mounting Height	0.8-1.2m(2.7-4ft)
Sensitivity	2.0°C at 0.6m/s (3.6°F at 2.0ft./s)
Detectable Speed	0.3-1.5m/s(1-5ft/s)
Power Input	3-9VDC Alkaline or Lithium Battery
Operating Voltage	2.5V - 10VDC
Current Draw	Max. 3mA(In Walktest, LED on) 10uA(In Standby)
Alarm Period	Approx 2.5sec
Alarm Output	Form C-Solid State Switch: 10VDC, 0.01A
Battery Saving Timer	Approx. 120sec or 5sec
Tamper Switch	Form C opens when cover removed
Pulse Count	Approx 20sec 2or4
Warm-up Period	Approx. 2min
LED Indicator	Disable during normal operation Enable during walk test
Weatherproof	IP54
Operating Temperature	-20 - +50°C (-4 - +122°F)
Environment Humidity	95% Max
RF Interference	No Alarm 30V/m
Mounting	Wall, Pole
Weight	480g(16.9oz)
Accessories	Pole mount kit, Screw kit, Area Masking Plate

[Dimensions]

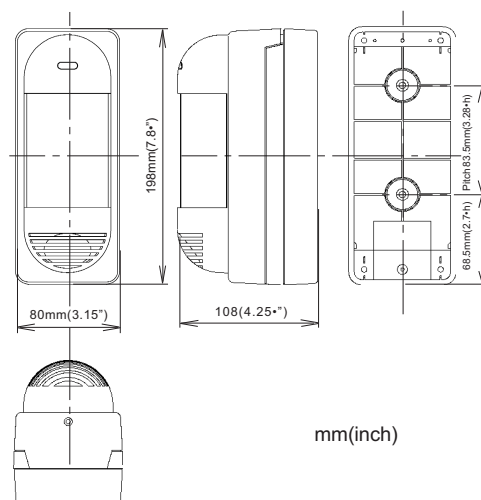

Note: Specifications and design are subject to change without prior notice.

NOTE

This unit is designed to detect movement of an intruder and activate an alarm control panel. Being only a part of a complete system, we cannot accept responsibility for any damages or other consequences resulting from an intrusion. This Product conforms to the EMC Directive.89/336 EEC.

compound
SECURITY SYSTEMS

CSS LTD +44 (0)1685 350418
WWW.COMPOUNDSECURITY.CO.UK